

GRAB BARS **GW11 02 04 02 Polished grab bar 400 mm****Product description**

400 mm grab bar
1,5 mm AISI 304 stainless steel tubing with 32 mm outside diameter
Polished finish
Heavy duty

Technical specifications:

400 mm AISI stainless steel grab bar to be installed in vertical or horizontal position. The tube has an outside diameter of 32 mm with a thickness of 1,5 mm, bended on both ends 90°. Mounting flanges are manufactured in AISI 304 stainless steel with 2.5 mm thickness and 76,9 mm de diameter and are fixed to the ends of the bar using M10 screws. Mounting flanges have three holes for wall attachment. Snap flange covers are manufactured in AISI 304 stainless steel with 0,5mm thickness and 77,6 mm diameter. Each cover snaps over mounting flange to conceal mounting screws. Clearance between the grab bar and wall is 43mm. The assembled unit has suitable resistance to corrosion. The grab bar is fixed to the wall by means of 6 nylon wall plugs (8X50) and AISI 304 stainless steel screws (5X60). Grab bar will support loads in excess of 120Kg if properly installed. The grab bar code is GW11 02 04 02 manufactured by GENWEC WASHROOM S.L. – Av. Joan Carles I, 46-48 08908 L'Hospitalet de Llobregat.

Technical characteristics**Product specifications**

- Mounting flanges manufactured in AISI 304 stainless steel with 2,5mm thickness and 76,9mm diameter
- AISI 304 stainless steel tubing with 32mm outside diameter and 1,5mm thickness
- Snap flange covers manufactured in AISI 304 stainless steel with 0,5mm thickness and 77,6mm diameter
- Polished finish
- Clearance to wall: 43mm
- Grab bar supports 120 Kg if properly fixed

Packaging specifications

Packaging: Individual box and plastic bag
Package measures: 85x85x500 mm
Product measures: 80x480x43mm
Carton units: 20
Pallet units: 160 (*)

(*) Maximum height 1,1m.

GRAB BARS **GW11 02 04 02 Polished grab bar 400 mm**

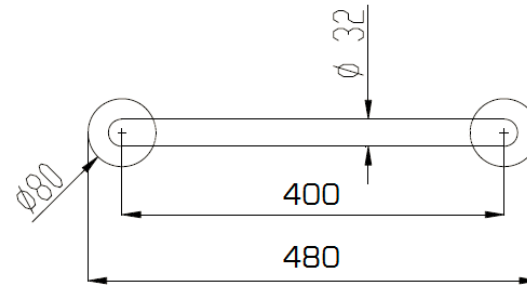

Installation advice

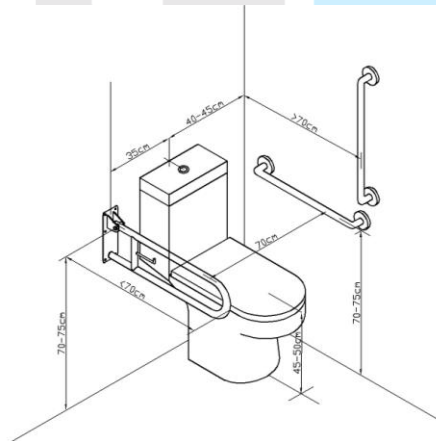

Electrical isolation:

GENWEC WASHROOM has electrical isolation kits for all grab bars manufactured in stainless steel. The kit code for related grab bar is GW11.01.90.00 (2 units).

Cleaning: A cotton cloth slightly dampened in a soapy solution is recommended. Then dry off.