

**INSTRUCCIÓN PARA SUSTITUCIÓN
DE FILTRO ULTRAFILTRACIÓN FT91**
ULTRAFILTRATION FILTER REPLACEMENT INSTRUCTIONS FT91

IG19004-01

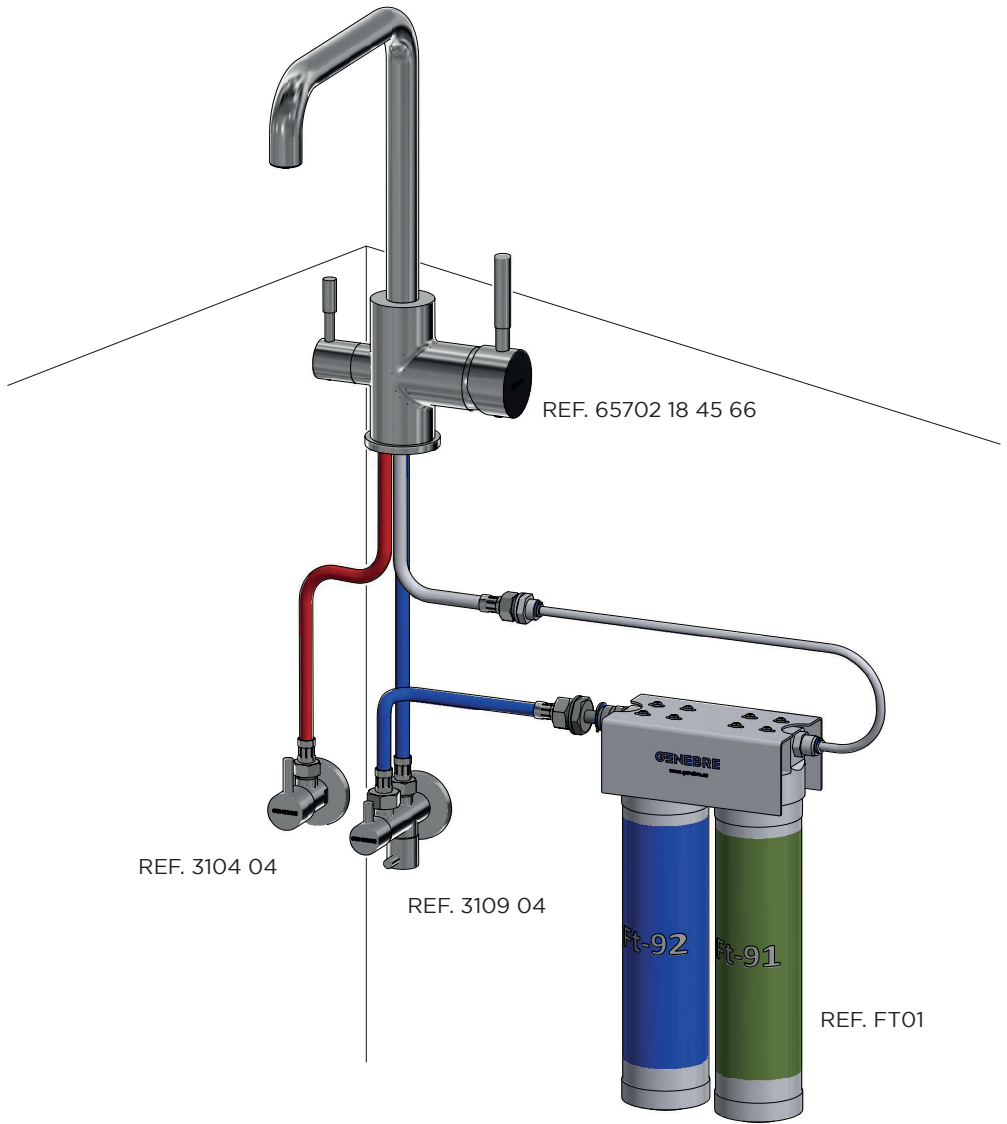

EJEMPLO DE MONTAJE CON FREGADERA 65702 18 45 66
SINK MIXER 65702 18 45 66 ASSEMBLY EXAMPLE



EJEMPLO DE MONTAJE CON FREGADERA 65700 18 45 66
SINK MIXER 65700 18 45 66 ASSEMBLY EXAMPLE

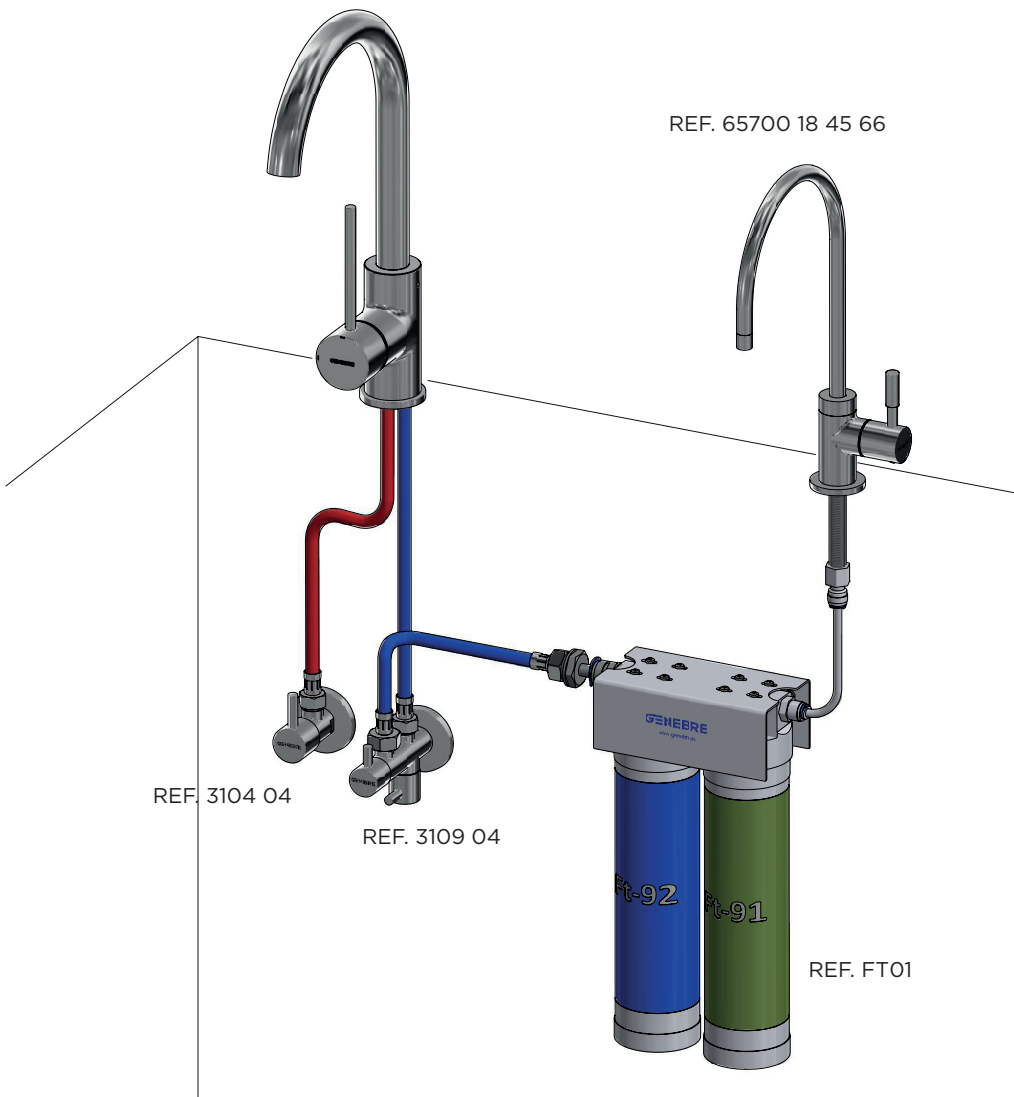

1

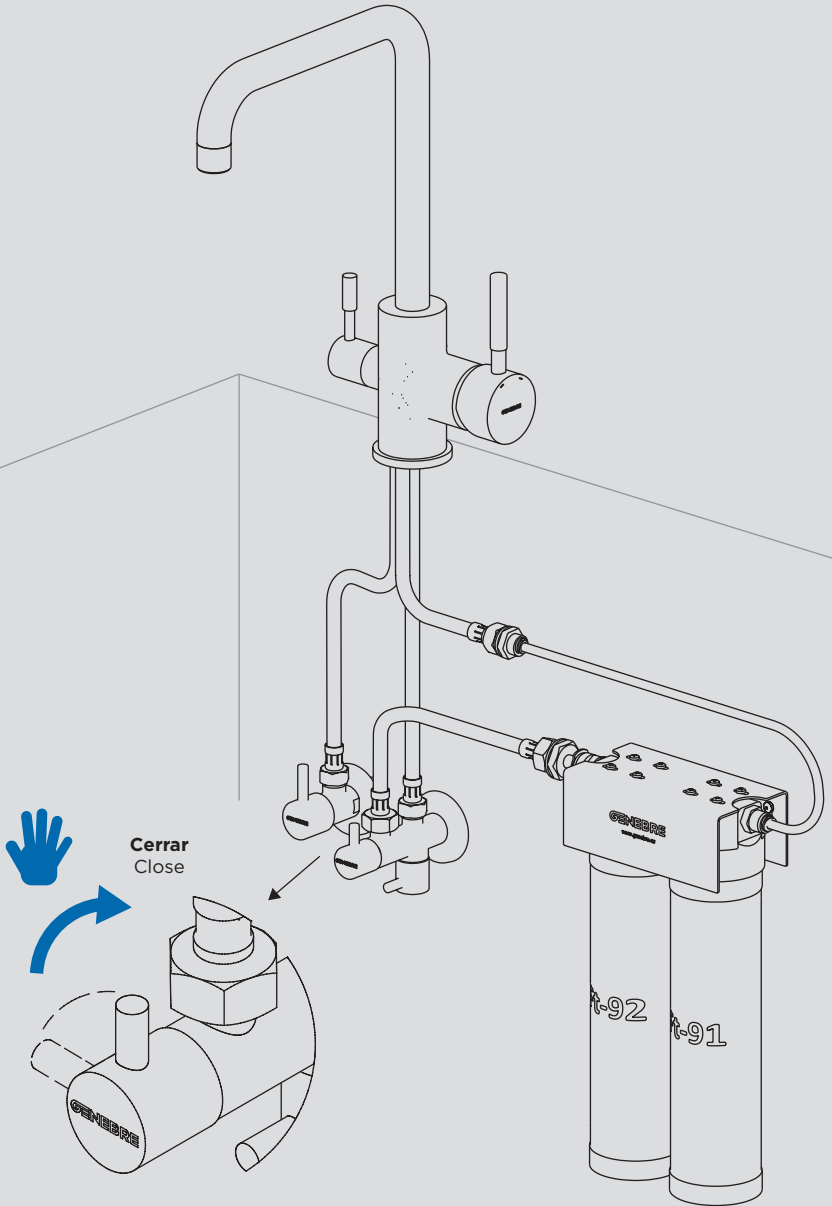

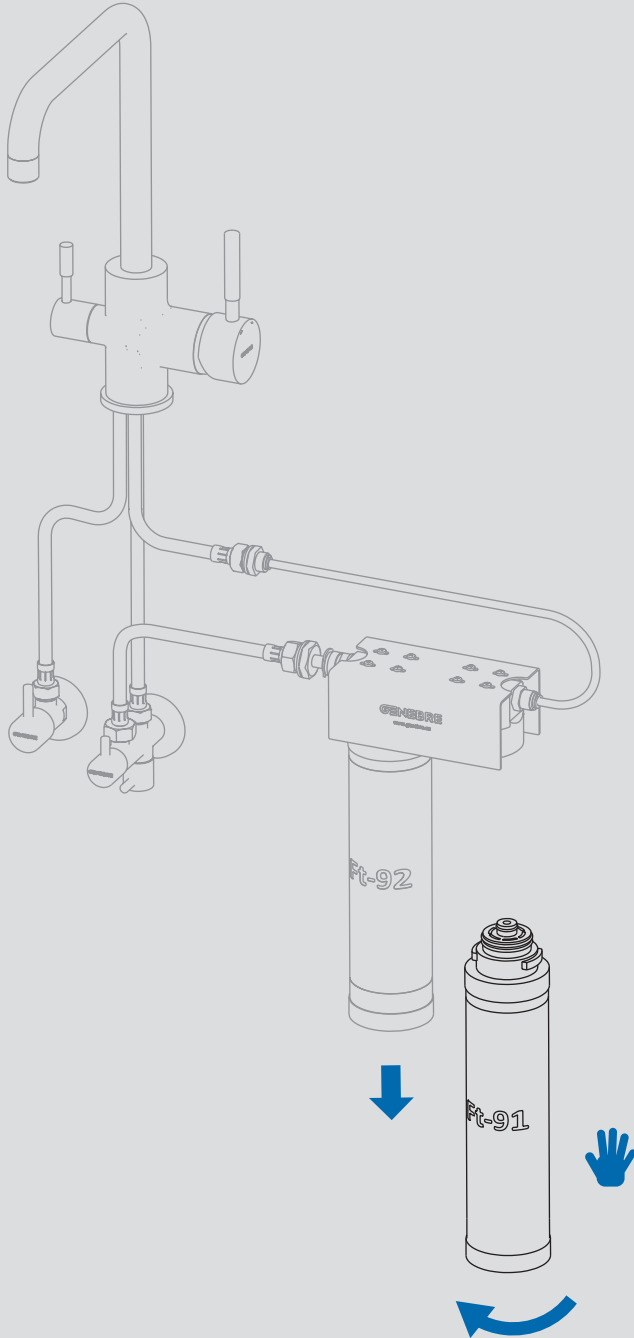

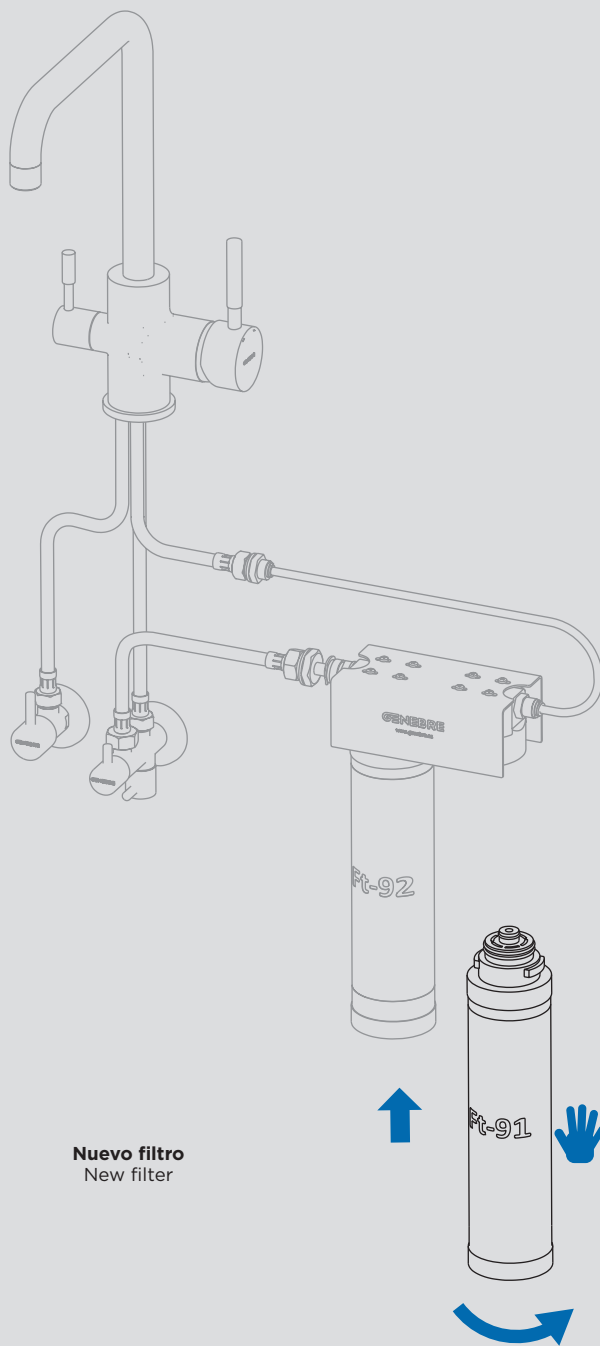

Nuevo filtro
New filter

Regulación de caudal
Flow regulation

2 L/min.



0.5 L/min. Min



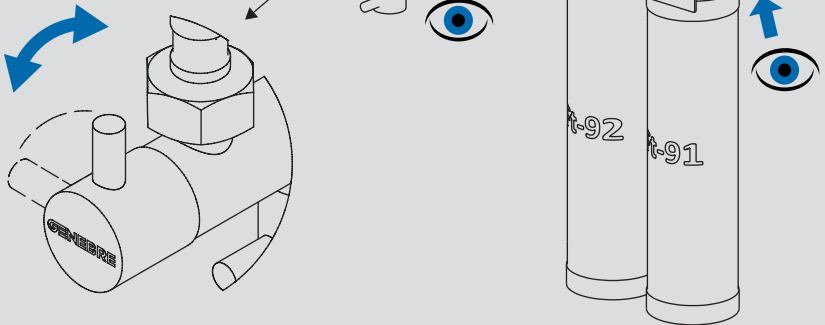



4 L/min. Max.



MUY IMPORTANTE / VERY IMPORTANT

Una vez instalado el filtro dejar salir 20 litros o hasta que el agua deje de salir turbia
Once the filter has been installed let out 20 liters out or until the water stops coming out cloudy

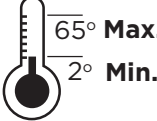
CONDICIONES DE SERVICIO DE LA INSTALACIÓN
INSTALLATION WORKING CONDITIONS

		
		
	<p>1 Año / 7.500 litros 1 Year / 7.500 liters Max.</p>	<p>1 Año / 5.670 litros 1 Year / 5.670 liters</p>

LIMPIEZA / CLEANING

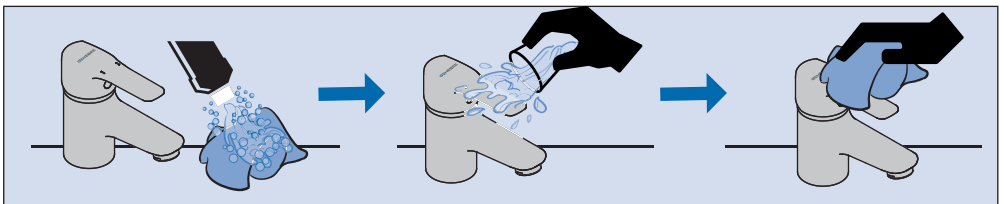
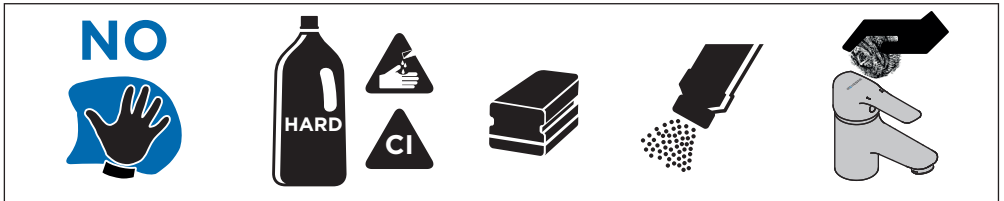

SÍMBOLOS / SYMBOLS

	<p>Fijar con la mano / Fix by hand</p>		<p>Sentido de giro / Turning direction</p>
--	--	---	--

GENEBRE